

2009

# An Adaptive Adjacent Channel Interference Cancellation Technique

Robert H. Morelos-Zaragoza

*San Jose State University*, robert.morelos-zaragoza@sjsu.edu

Shobha Kuruba

*San Jose State University*

Follow this and additional works at: [https://scholarworks.sjsu.edu/ee\\_pub](https://scholarworks.sjsu.edu/ee_pub)



Part of the [Electrical and Computer Engineering Commons](#)

---

## Recommended Citation

Robert H. Morelos-Zaragoza and Shobha Kuruba. "An Adaptive Adjacent Channel Interference Cancellation Technique" *Faculty Publications* (2009): 1-4.

This Article is brought to you for free and open access by the Electrical Engineering at SJSU ScholarWorks. It has been accepted for inclusion in Faculty Publications by an authorized administrator of SJSU ScholarWorks. For more information, please contact [scholarworks@sjsu.edu](mailto:scholarworks@sjsu.edu).

# An Adaptive Adjacent Channel Interference Cancellation Technique

Robert Morelos-Zaragoza  
Department of Electrical Engineering  
San Jose State University  
San Jose, CA 95192-0084 USA  
R.Morelos-Zaragoza@IEEE.org

Shobha Kuruba  
Department of Electrical Engineering  
San Jose State University  
San Jose, CA 95192-0084 USA

**Abstract**—In this paper, an adaptive adjacent channel interference (ACI) technique is proposed. Results for BPSK modulation with rectangular and square-root raised-cosine pulse shaping, under AWGN conditions, are obtained showing the proposed method to be effective in improving performance under high levels of interference. Basically, the idea is to send pilot signals and then to use them in estimating the amount of ACI in the frequency domain. The estimated spectral error is used to modify tap weights of an adaptive frequency-domain filter. Our simulation results reported suggest that ACI can be effectively reduced with the proposed technique. At the system level, the requirements of analog front-end channel-select and other filters can be relaxed, resulting in a cost-effective receiver design.

## I. INTRODUCTION

In frequency-division multiple-access communication systems, such as GSM, high spectral efficiency results in interference from adjacent channel signals that may result in a high noise floor and a consequent and sometimes severe irreducible bit error rate. Nonlinear power amplifiers may result in spectral re-growth that also causes this error floor effect to be present even if the communication system is designed to minimize this ACI. In this paper an adaptive equalization approach is considered to combat ACI in wireless communication systems.

The paper is organized as follows. In section II, a brief description of the ACI problem is presented and previous work overviewed. Section III introduces the proposed method, and highlights the frequency domain approach with an adaptive filtering technique. The effects of ACI on the average bit error rate of a BPSK communication system are studied in section IV, assuming additive white Gaussian noise. Simulation results are presented for two different types of pulse shapes, rectangular and square root raised-cosine, for different amounts of adjacent channel spacing and for different power ratios between the channel of interest and the neighboring channels, all at different signal-to-noise ratios per bit.

## II. BACKGROUND

### A. Benefits of Adjacent Channel Interference Cancellation

ACI cancellation improves receiver performance in terms of average bit error probability. It allows channels to be spaced

closer than it would be possible without ACI compensation. A digital ACI cancellation method significantly relaxes the analog front-end filters specifications and thus reduces system cost. Moreover, software-defined radios operate by converting RF signals from bandpass to lowpass and using appropriate digital filters to select the channel of interest. As a way to reduce the amount of processing and power consumption in the analog components, clever methods to diminish the effect of ACI are desirable.

The bandwidth of each channel in a wireless communication system will generally depend on both the symbol rate and the shape of the signaling pulses being used. Consider a bandpass modulated signal at center frequency  $f_c$  in the channel that the receiver aims to detect. The channels located at center frequencies  $f_c - f_d$  and  $f_c + f_d$  are known as the adjacent channels. The interference from these channels leaking into the detection path of the desired channel is known as adjacent channel interference.

A wireless communication receiver has a channel-select (CS) filter in the first stage of its analog front end, with the purpose of removing interference from other channels and systems. However, if the channel spacing  $f_d$  is small, as is the case in wireless communication systems with high spectral occupancy, then relatively high quality CS and other bandpass filters are required. This necessarily increases the cost of the receiver and generally may increase power consumption. In addition, if the roll off characteristic of the pulse-shaping filter is not sufficiently sharp, then adjacent channel signals will leak into the received signal path. Also, when the power of the adjacent channels is greater than the power of the channel of interest, the front-end filters are not able to isolate the signal of interest from the interferers.

Importantly, ACI may be regarded as colored noise at the input of the matched filter, because its power spectral density is not uniform across all frequencies. This imposes a noise floor on the system that is dependent on two factors: (1) the amount of spectral overlap between the adjacent channels and the channel of interest; and (2) the ratio of the power of the adjacent channel and the power in the desired channel. This results in an irreducible bit error rate (BER), i.e., the BER value remains the same and independent of the SNR per bit. One goal of the proposed method is to either reduce or remove this irreducible BER.

## B. Previous work

A joint estimation method using multiple antennae for interference cancellation is addressed in reference [1]. The application is multiple-input multiple-output (MIMO) communication system over a flat Rayleigh fading channel. Each receiving antenna is connected to a set of sub-receivers and each sub-receiver is tuned to one of the transmitting antenna. A method to estimate data from all the carriers using maximum likelihood estimator in AWGN is proposed. Since all the bits are estimated together, any error in one channel has the potential to produce errors in all the other channels. Results presented for the case of three transmit and three receive antennas show that the BER is close to that without ACI for different pulse shapes, different power ratios and channel spacing as close as 0.4 times the bit rate.

The method proposed in [3] is a type of data-aided joint estimation method. It is based on a technique used for improving speech quality in the presence of noise by using directional microphones. One microphone captures noisy speech and the other one captures mainly noise and some speech since it is directed away from the speaker. The noise in both signals is correlated. The noise only signal is used as reference for an adaptive filter to subtract noise from the noisy speech signal. The enhanced speech signal is used as reference to another adaptive filter to remove speech from the reference noise signal.

When applied to the ACI problem, the use of two adaptive filters is proposed: one to estimate the process of interference and the other to estimate the component of the signal of interest in the interfering channel. During training (pilot) sequence, the process from interferer to channel of interest is estimated and also the path from the channel of interest to the interfering channel is estimated using stochastic gradient method. Once the two filters converge, during data sequence, the signal at the interfering channel is filtered using filter1 and subtracted from signal of interest. Results are presented as a function of SNR improvement and show the method to be effective in improving the signal-to-interference ratio by at least 3dB even at high level of interference.

In reference [5], a digital filter with adjustable number of taps is proposed. Here an estimate of interference is used to add or remove taps at the tails of square-root raised-cosine (SRRC) filters. As a result, when there is more interference, a sharp roll off SRRC filter is applied. The filter roll-off factor is relaxed when there is no ACI by reducing the number of taps used. This is an advantage in a mobile receiver as it saves power due to reduced processing. Savings of up to 75% are reported as estimated through simulations.

## III. PROPOSED METHOD

This paper takes a data-aided (DA) approach to the problem of estimation and cancellation of adjacent channel interference. The basic idea is to transmit known pilot signals and to estimate the amount of ACI by comparing the spectrum of the received signal with the spectrum of the pilot signal. This estimate of the spectrum error is used to modify tap weights of a frequency domain filter. The weights should be updated in such a way that the frequencies where ACI is present are de-

emphasized with respect to the rest of the signal. This approach is expected to provide a significant improvement in the signal-to-interference ratio thus resulting in a better error performance.

Figure 1 shows a block diagram of the proposed ACI cancellation method. In the training stage a symbol sequence that known to the receiver is transmitted. This signal, along with the adjacent channel interference and AWGN, arrives at the receiver. The spectrum of the received signal is estimated using the FFT algorithm. This spectrum is compared with the spectrum of the pilot sequence and the error provides an estimate of the adjacent channel interference. The error signal is used to adjust weights of a frequency domain adaptive filter. The weights are applied to the coefficients of the FFT of the received signal, in much the same way as an OFDM receiver operates, in order to minimize interference.

The output of the adaptive filter is fed to a matched filter followed by a decision device. A spectral mask is applied to the weights so that weight adjustments occur only for those frequency components where the signal is expected to overlap with the adjacent channel. It is important to point out that the rest of the weights remain at unit value, and the received signal is not modified for those frequencies, to preserve signal integrity. This filter has lower complexity compared to that of an OFDM receiver. Finally, tap weights are updated only during the transmission of pilot sequence.

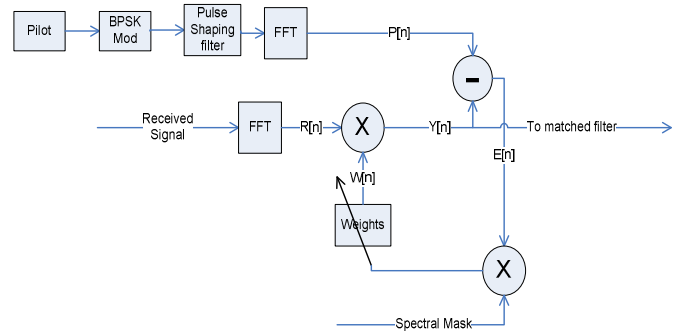

Figure 1. Block diagram of the proposed method.

## IV. PERFORMANCE RESULTS

In this section, the performance of a BPSK receiver with AWGN with ACI is investigated as a function of the pulse shaping filters, the channel spacing relative to the bit rate, the ratio of the signal power to the power in the adjacent channels and the SNR per bit.

Figure 2 shows the performance of BPSK modulation under ACI using rectangular signaling pulses is presented for various channel spacing  $f_d$  in the range of 0.75 to 1.75 times the bit rate and a carrier-to-interference ratio  $C/I = 0$  dB. Remarkably, the best performance is achieved with channel spacing equal to the bit rate  $R_b$ . Figure 3 shows the performance of BPSK modulation with  $C/I = 0$  dB and channel spacing  $f_d = 0.75 R_b$ . Notice the presence of an error floor that is made lower with the proposed technique.

Improvements by a factor of 10 are obtained with larger values of channel spacing (not shown here.) At  $f_d = 1.25 R_b$ , the error floor disappears and a gain of approximately 5 dB is obtained using the proposed cancellation technique, as shown in Fig. 4.

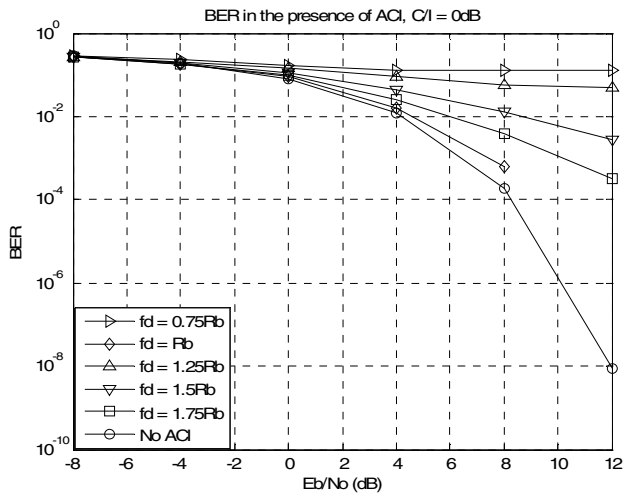

Figure 2. Performance of BPSK under ACI with rectangular pulse shaping and  $C/I = 0$  dB.

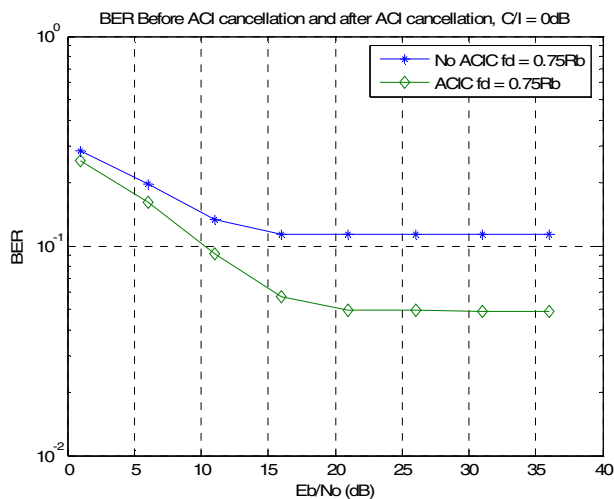

Figure 3. Performance of BPSK with and without ACI cancellation, rectangular pulse shaping and channel spacing  $f_d = 0.75R_b$ .

The performance of BPSK modulation under ACI using SSRC pulses is presented in Figs. 5 and 6 for a roll-off factor  $\alpha = 0.25$ , channel spacing in the range of 0.75 to 1.25 times the bit rate and two values of  $C/I$ . As Fig. 5 shows, at a  $C/I$  value of 10 dB results in an error performance under ACI that is insensitive to channel spacing in the range shown. As interference from adjacent channels becomes more severe,

channel spacing equal to the bit rate degrades. This is shown in Fig. 6.

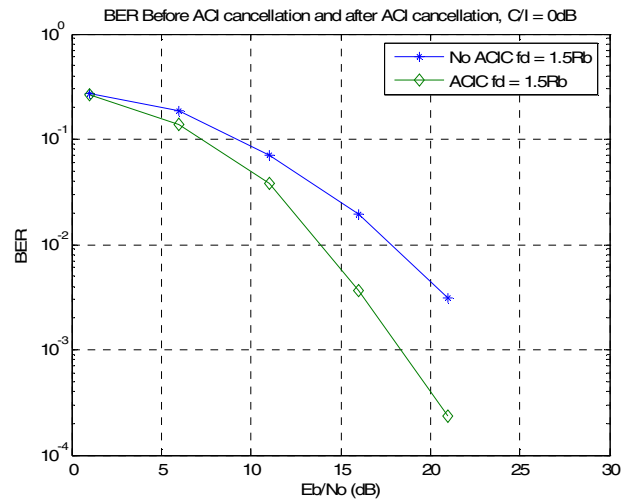

Figure 4. Performance of BPSK with and without ACI cancellation, rectangular pulse shaping and  $C/I = 0$  dB.

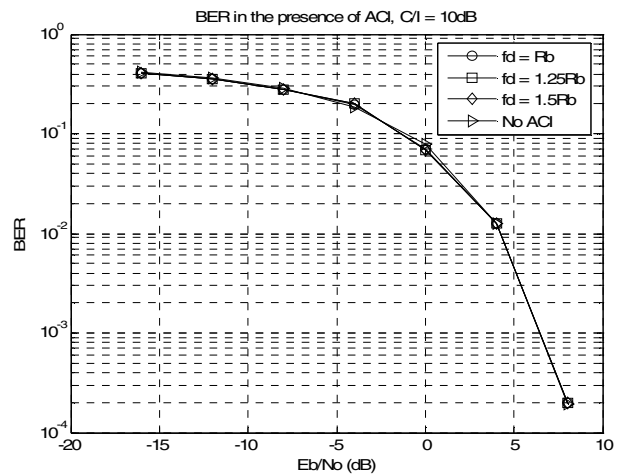

Figure 5. Performance of BPSK under ACI with SSRC pulse shaping of roll-off factor  $\alpha = 0.25$  and  $C/I = 0$  dB.

At a larger roll-off factor value of  $\alpha = 0.95$ , performance of BPSK with SSRC pulses under ACI degrades considerably and the proposed technique partially improves the BER of the system. As shown in Fig. 7, channel spacings of the order of the bit rate result in an irreducible BER that is effectively lowered with the adaptive cancellation technique proposed in this paper.

On the other hand, for sufficiently spaced channels, with separation  $f_d = 1.25 R_b$ , ACI cancellation is expected to yield a gain of approximately 2 dB in error performance.

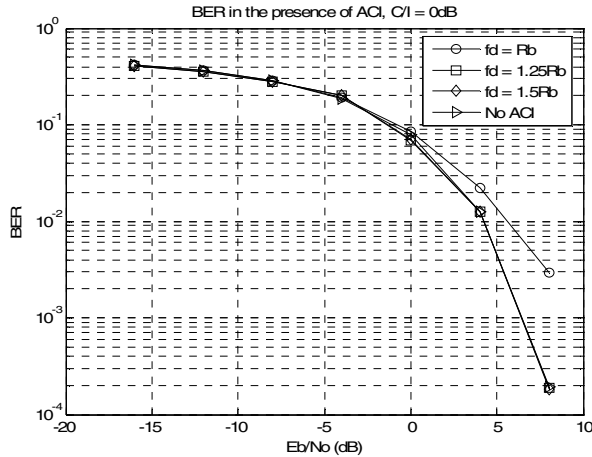

Figure 6. Performance of BPSK under ACI with SRRC pulse shaping of roll-off factor  $\alpha = 0.25$  and  $C/I = 0$  dB.

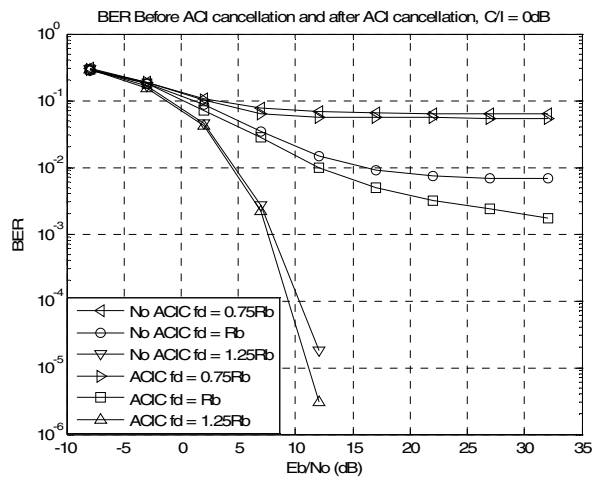

Figure 7. Performance of BPSK using ACI cancellation, SRRC pulse shape with roll-off factor  $\alpha = 0.95$  and channel spacing  $f_d = 0.75R_b, R_b, 1.25R_b$

## V. CONCLUSIONS AND FINAL REMARKS

The primary focus of this project is to prove the effectiveness of a data-aided frequency domain approach to the estimation and cancellation of ACI and thus to reduce the noise floor enforced by the presence of interference from neighboring channels. Results on the performance of BPSK modulation under ACI with and without the cancellation technique have been presented. SRRC filters are much less sensitive to ACI than rectangular shaping filters. For channel spacing of the order of the bit rate, the proposed cancellation technique improves performance of the system in all cases reported here.

The current implementation operates on the addition of correction terms to the adaptive filter taps, based on the difference between the received signal FFT coefficients and the reference FFT coefficients. An alternative implementation can rely on the computation of the ratio of the two FFT coefficients and then an update of the weights by multiplying by a correction factor. Future work includes extension to multi-path fading and other impairments present in general wireless channels and comparison of performance to that obtained by other ACI cancellation methods. The method introduced in this paper can be directly applied to OFDM systems, which already use pilot symbols for parameter estimation and frequency domain equalization to combat multi-path fading. Another objective at the system level is to relax the requirements of analog front-end channel selection and bandpass filters. This is hereby achieved by a digital ACI cancellation technique in the baseband domain that reduces the cost of analog components

## REFERENCES

- [1] D. Gidnoy and I. Kalet, "Adjacent Channel Interference Cancellation for MSK-Type Signals Using Antenna Diversity in Rayleigh Fading Environments," *IEEE Trans. Comm.*, vol. 52, no. 2, pp. 317 – 325, February 2004.
- [2] J. D. Laster and J.H. Reed, "Interference rejection in digital wireless communications," *IEEE Signal Processing Magazine*, vol. 14, no. 3, pp. 37 – 62, May 1997.
- [3] B. R. Petersen and D. D. Falconer, "Suppression of adjacent-channel, co-channel, and inter-symbol interference by equalizers and linear combiners," *IEEE Trans. Comm.*, vol. 42, no. 12, pp. 3109 – 3118, December 1994.
- [4] B. A. Hedstrom, R. Lynn Kirlin, and P. F. Driessen, "Adaptive Cancellation of Adjacent Channel Interference," *Proc. IEEE Pacific Rim Conference on Communications, Computers and Signal Processing*, June 1st – 2nd, 1989.
- [5] Peter Mosen, "MMSE Equalization of Interference on Fading Diversity Channels", *IEEE Trans. Comm.*, vol. Com-32, No.1, January 1984.
- [6] R. Veljanovski, J. Singh, M. Faulkner, "A proposed reconfigurable digital filter for a mobile station receiver," *Proc. IEEE Global Telecommunications Conference*, vol. 1, pp. 524 – 528, November 2002.